



## NIAGARA WORLD BRANCHS



**Contact US**  
www.niagaracanadian.com

### Headquarter



3453 New St., Burlington, ONL 7N1N4  
Ontario, Canada  
+1 647 868 0968  
info@niagaracanadian.com

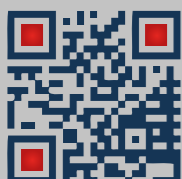

Niagara Canada



niagara\_canadian

### Our Branches



Sharjah - UAE



Istanbul - Turkey



Brussels - Belgium



Riyadh - Saudi Arabia



Bratislava - Slovakia



Cairo - Egypt

"Canadian Technology"

TOUCH TO YOUR  
MODERN



BATHROOM



www.niagaracanadian.com  
8 Years Warranty

## SUSTAINABILITY: THINK GREEN

The 'Think Green' slogan refers to our mission to carry out constant research for greener technology implementation and the use of renewable resources.

We implement strategies to:

- reduce environmental impact and resource consumption
- reduce energy consumption
- eliminate toxic substances or pollutants released into the environment

By creating sanitary ware designs that facilitate cleaning, we aim to reduce the use of detergents and excessive amounts of water and this together with improving the water efficiency of WCs, contributes to an overall reduction in water consumption. All round pre-production, production, transportation, use and recycling phases, are continuously monitored and improved.



1999 → 2019

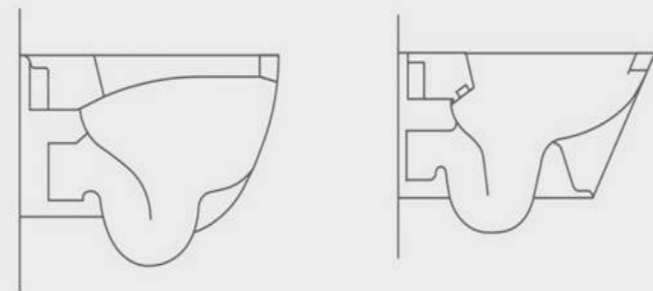

6L



3L





# About us

**Founded in 1995, Niagara today is one of the best Canadian Company able to offer the Highest productive quality in Ceramic & Sanitary Ware Sector**

Niagara is one of the largest ceramic & sanitary ware industry in the worlds and it was founded one center offers many ceramic & sanitary ware services and enjoys high expertise and successful in the field of the ceramic & sanitary ware industry, which covers large parts of the worlds.

We excel accuracy, and ease of access to the service and professionalism of the urgent and valuable ourdesire to achieve full satisfaction to our customers.

We have a team consisting of administrators, engineers and highly experienced workers, which means that your work will always be accurate whatever the field of your work.

We are in Niagara apply a dynamic approach for each project. This technique High efficiency allows us to do a great number of projects and completed at incredible prices – so even Urgent projects take a full share of the care and precision with speed at the same time – and As your partners in the field of ceramic & sanitary ware, we stand ready to go beyond your expectations in dealing With any of your own projects and at all times.



**A2109**

WASHDOWN ONE-PIECE TOILET

Size: 690 X 375 X 805 mm

S-trap, 250 mm Roughing-in

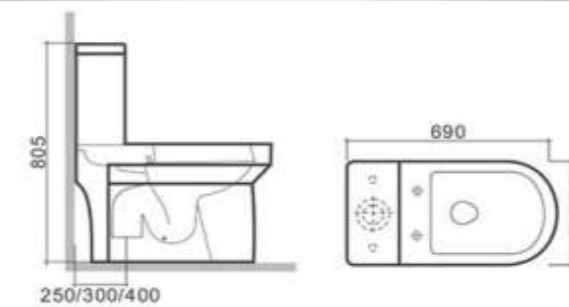

**SY1003**

WALL-HUNG TOILET

Size: 530 X 360 X 370 mm

P-trap: 180 mm roughing-in

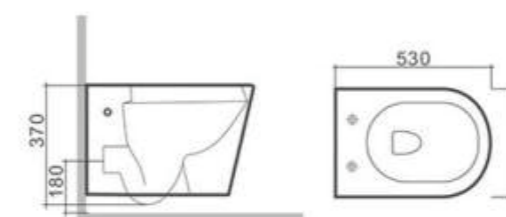

**SY2028P**

PEDESTAL BASIN

Size: 560 X 460 X 860 mm

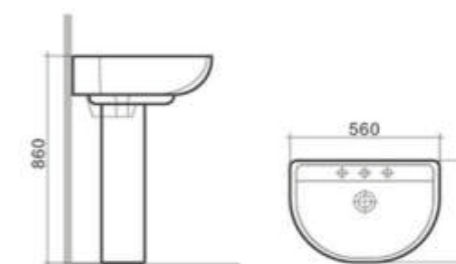

UF - COVER





**A2145**

WASHDOWN ONE-PIECE TOILET

Size: 650 X 360 X 740 mm

S-trap, 250 mm Roughing-in

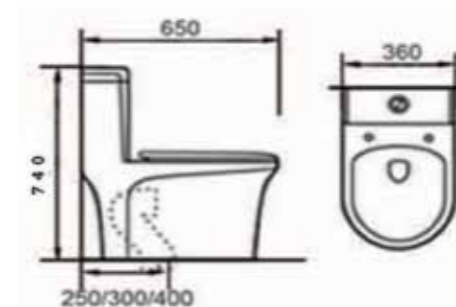

**SY1312**

WALL-HUNG TOILET

Size: 530 X 380 X 360 mm

P-trap: 180 mm roughing-in



Rimless

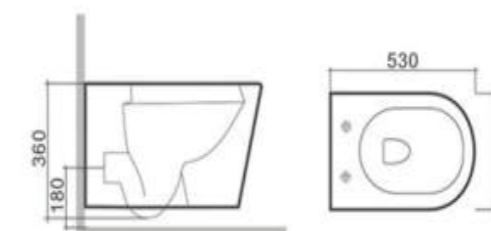

**H224**

WALL-HUNG BASIN

Size: 460 X 560 X 370 mm

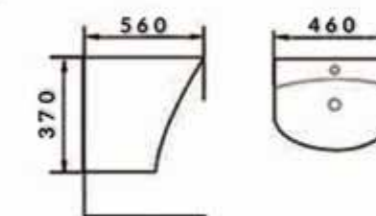



**A2149**

WASHDOWN ONE-PIECE TOILET

Size: 680 X 400 X 785 mm

S-trap, 250 mm Roughing-in

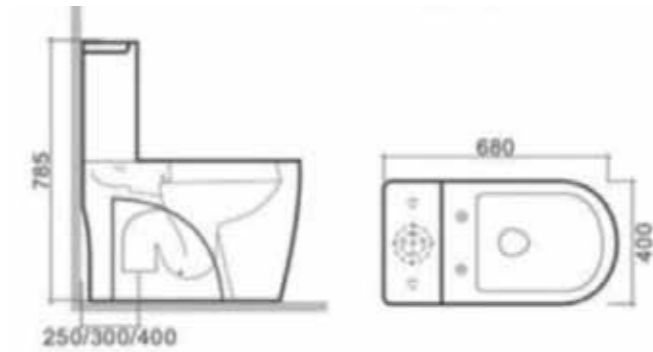

**SY1006**

WALL-HUNG TOILET

Size: 570 X 390 X 350 mm

P-trap: 180 mm roughing-in

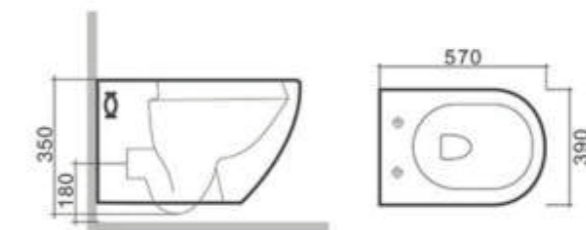

**SY2032P**

PEDESTAL BASIN

Size: 610 X 480 X 860 mm

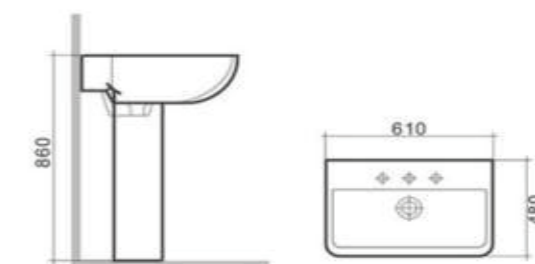



**A2172**

WASHDOWN ONE-PIECE TOILET

Size: 720 X 380 X 770 mm

S-trap, 250 mm Roughing-in

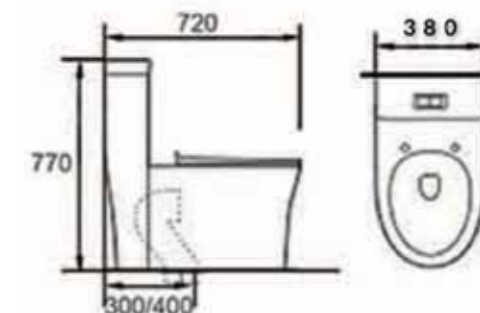

**SY1004**

WALL-HUNG TOILET

Size: 545 X 370 X 320 mm

P-trap: 180 mm roughing-in



Rimless



**H226**

WALL-HUNG BASIN

Size: 460 X 460 X 370 mm

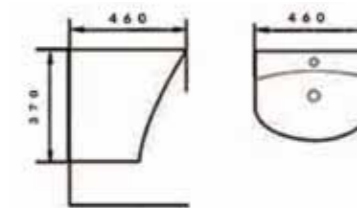

UF - COVER





**A2317**

WASHDOWN ONE-PIECE TOILET

Size: 680 X 380 X 780 mm

S-trap, 250 mm Roughing-in

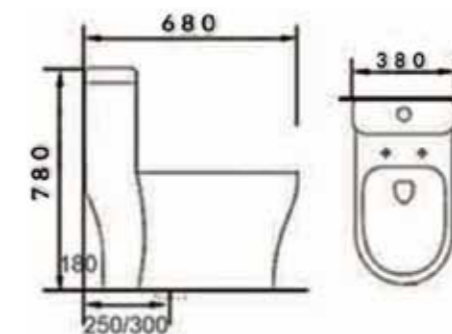

**SY1013**

WALL-HUNG TOILET

Size: 490 X 365 X 370 mm

P-trap: 180 mm roughing-in



**H3328**

WALL-HUNG BASIN

Size: 540 X 470 X 440 mm

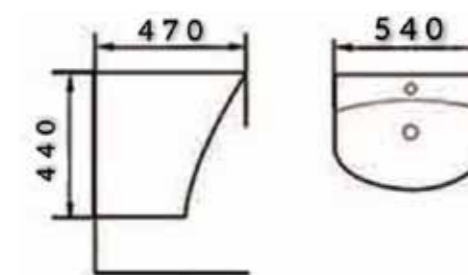





### E5200

WASHDOWN TWO-PIECE TOILET  
Size: 665 X 345 X 830 mm  
S-trap: 250 mm Roughing-in  
P-Trap: 180 mm Roughing-in

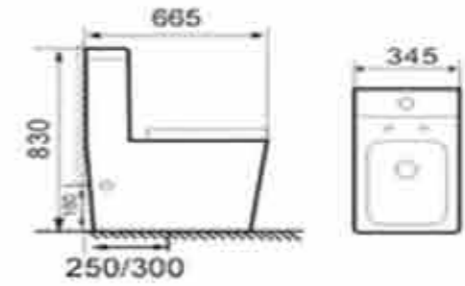

### SY1002

WALL-HUNG TOILET  
Size: 545 X 360 X 360 mm  
P-trap: 180 mm roughing-in

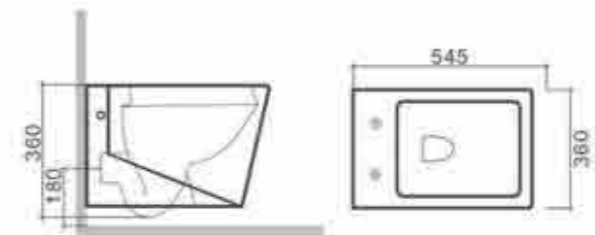

### H223

WALL-HUNG BASIN  
Size: 515 X 450 X 415 mm

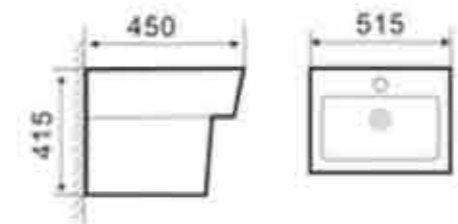



**E5201**

WASHDOWN TWO-PIECE TOILET

Size: 700 X 365 X 830 mm

S-trap: 250 mm Roughing-in

P-Trap: 180 mm Roughing-in

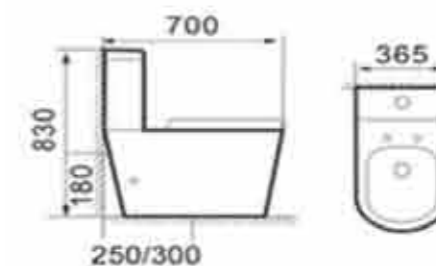

**SY1005**

WALL-HUNG TOILET

Size: 555 X 355 X 340 mm

P-trap: 180 mm roughing-in

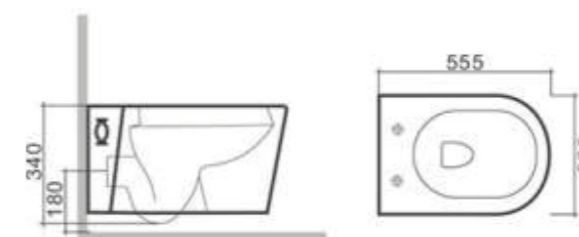

**H225**

WALL-HUNG BASIN

Size: 530 X 440 X 360 mm

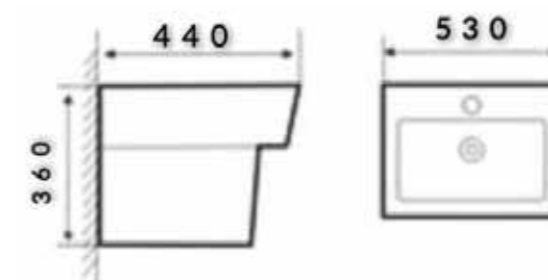



**E6003**

WASHDOWN TWO-PIECE TOILET

Size: 650 X 370 X 795 mm

S-trap, 250 mm Roughing-in



**SY1321**

WALL-HUNG TOILET

Size: 520 X 350 X 365 mm

P-trap: 180 mm roughing-in



Rimless



**B121**

PEDESTAL BASIN

Size: 605 X 465 X 870 mm

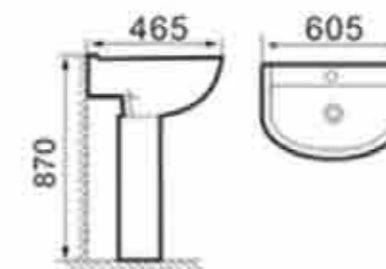

UF - COVER





UF - COVER



**SY1013F**

- Back to wall toilet
- Size : 545\*375\*800mm
- P-trap: 180mm roughing in



**SY1001F**

- Back to wall toilet
- Size : 555\*355\*800mm
- P-trap: 180mm roughing in
- S-trap: 100mm roughing in



**SY1016F**

- Back to wall toilet
- Size : 575\*415\*860mm
- P-trap: 180mm roughing in
- S-trap: 120/150mm roughing in



**SY1006F**

- Back to wall toilet
- Size : 570\*380\*810mm
- P-trap: 180mm roughing in
- S-trap: 120/150mm roughing in



**SY1014F**

- Back to wall toilet
- Size : 555\*365\*800mm
- P-trap: 180mm roughing in
- S-trap: 120/150mm roughing in



**SY1005F**

- Back to wall toilet
- Size : 565\*355\*800mm
- P-trap: 180mm roughing in
- S-trap: 120/150mm roughing in



**SY1007**

- Wall-hung toilet
- Size : 575\*370\*810mm
- P-trap: 180mm roughing in



**SY1009**

- Wall-hung toilet
- Size : 550\*365\*800mm
- P-trap: 180mm roughing in



**SY1015**

- Wall-hung toilet
- Size : 530\*380\*810mm
- P-trap: 180mm roughing in



**SY1014**

- Wall-hung toilet
- Size : 490\*365\*800mm
- P-trap: 180mm roughing in
- MAT:

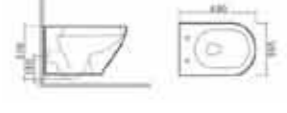

**SY1001**

- Wall-hung toilet
- Size : 555\*355\*800mm
- P-trap: 180mm roughing in



**SY1016**

- Wall-hung toilet
- Size : 580\*400\*890mm
- P-trap: 180mm roughing in



UF - COVER



**SY8831**

- Washdown one-piece toilet
- Size : 670\*370\*840mm
- S-trap: 250mm roughing in
- P-trap: 180mm roughing in



**SY389**

- Siphonic / Washdown one-piece toilet
- Size : 665\*355\*820mm
- Siphonic / S-trap: 300/400mm roughing in
- Washdown / S-trap: 250mm roughing in
- P-trap: 180mm roughing in



**SY3971**

- Siphonic / Washdown one-piece toilet
- Size : 680\*400\*790mm
- Siphonic / S-trap: 300/400mm roughing in
- Washdown / S-trap: 250mm roughing in
- P-trap: 180mm roughing in

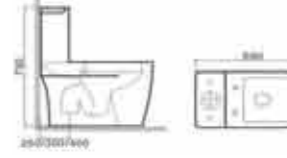

**SY8869**

- Washdown one-piece toilet
- Size : 660\*360\*800mm
- S-trap: 250mm roughing in
- P-trap: 180mm roughing in

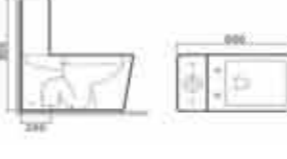

**SY3958**

- Washdown one-piece toilet
- Size : 710\*380\*820mm
- S-trap: 300/400mm roughing in
- P-trap: 180mm roughing in

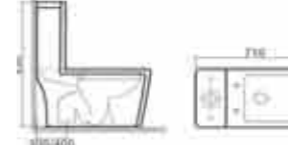

**SY3968**

- Siphonic / Washdown one-piece toilet
- Size : 685\*355\*775mm
- Siphonic / S-trap: 300/400mm roughing in
- Washdown / S-trap: 250mm roughing in
- P-trap: 180mm roughing in



**SY015**

- Washdown two-piece toilet
- Size : 700\*370\*810mm
- P-trap: 180mm roughing in



**SY022**

- Washdown two-piece toilet
- Size : 665\*400\*900mm
- P-trap: 180mm roughing in

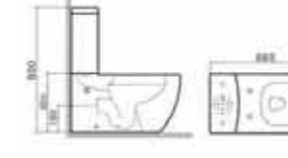

**SY2046**

- Washdown two-piece toilet
- Size : 650\*380\*818mm
- P-trap: 180mm roughing in

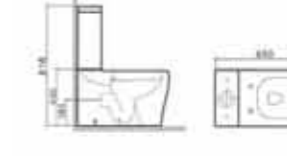

# INSTALLATION STEPS OF SPLIT TOILET

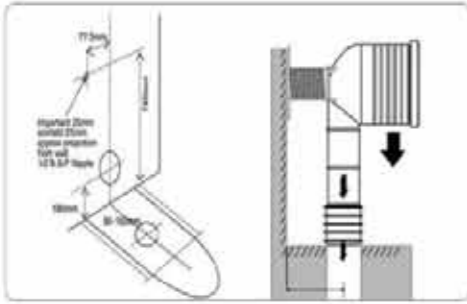

1 Position the water inlet, waste outlet and floor fixing bracket holes.

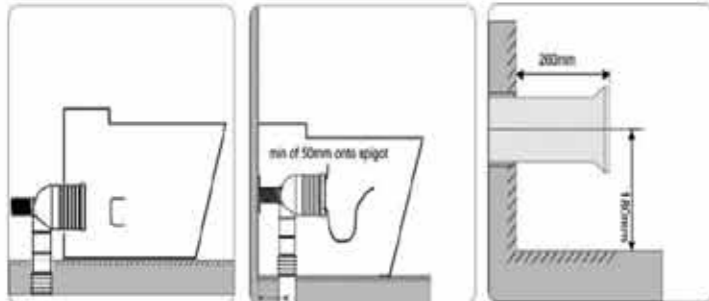
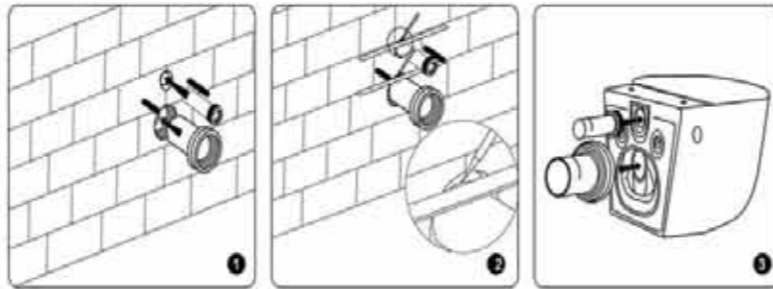

4 Align the pan back to the wall. 5 Connect pan spigot to pan collar. 6 Set up waste pipe and make sure the pipe is parallel to the floor.

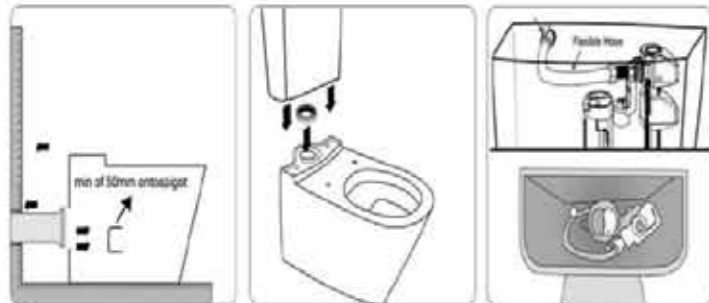
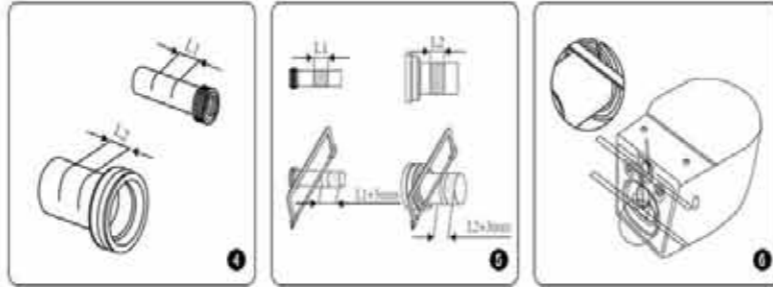

10 Align and push fully assembled toilet back to the wall. 11 Install ceramic cistern. 12 position stop tap then connect rear water inlet valve to stop tap.

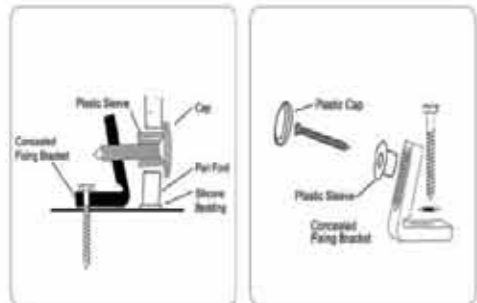

13 Connect the pan with foundation bolt. 14 Fix the pan by screwing the foundation bolt to the floor.

